

LOW BACKUP VOLTAGE SERIAL-INTERFACE REAL TIME CLOCK MODULE RX-4571 LC/NB/SA



Product Number (Please contact us)
 RX-4571LC : Q414571C2000100
 RX-4571NB : Q41457192000100
 RX-4571SA : Q41457152000100

- Built in frequency adjusted 32.768 kHz crystal unit.
- Interface Type : 3-wire serial interface
- Operating voltage range : 1.6 V to 5.5 V
- Wide Timekeeper voltage range : 1.0 V to 5.5 V / T_a = +25 °C
- Low backup current : 0.32 μA (Typ.) / 3 V
- 32.768 kHz frequency output function : C-MOS output With Control Pin
- Real-time clock function
 Clock/calendar function, auto leap year correction function, alarm interrupt function, etc.



Actual size



Block diagram

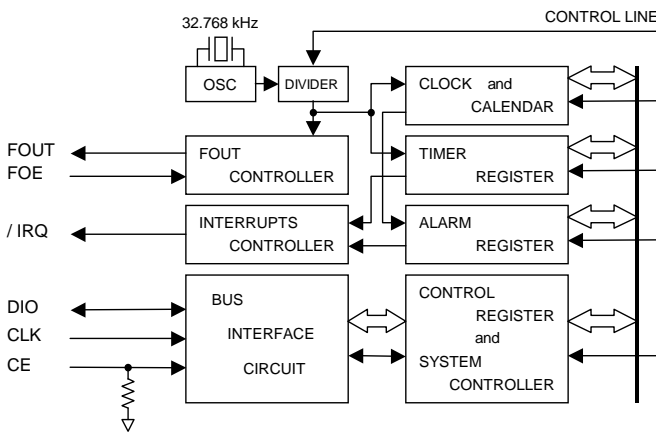

Overview

- **32.768 kHz frequency output function**
 - FOUT pin output (C-MOS output) , CL=30 pF
- **Timer function**
 - Timer function which can be set up between 1/4096 second and 4095 minutes.
- **Alarm function**
 - Alarm function can be set to any combination of day, day of week, hour, or minute.

Pin Function

Signal Name	Input / Output	Function
CE	Input	The chip enabled input pin 0. (It has a built -in pull-down resistance)
CLK	Input	The shift clock input pin for serial data transfer.
DIO	Bi-directional	The data input / output pin for serial data transfer.
FOUT	Output	32.768 kHz clock output pin with the output control function. (C-MOS)
FOE	Input	FOE pin control the condition of FOUT with FSEL1-bit, FSEL0-bit, etc.
/ IRQ	Output	Interrupt output (N-ch open drain)
VDD	—	Connected to a positive power supply.
GND	—	Connected to a ground.

Terminal connection / External dimensions

(Unit:mm)

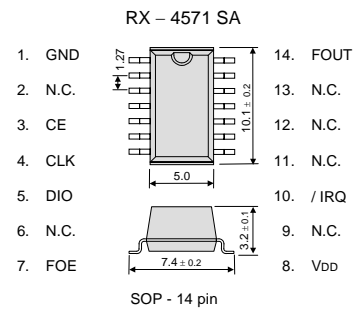
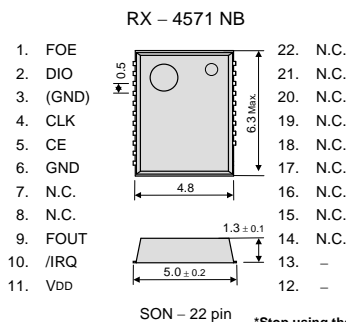
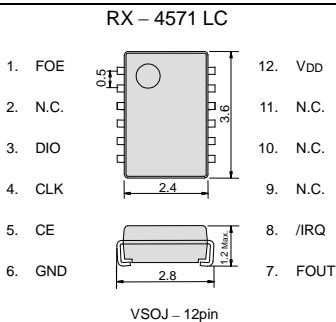

The metal case inside of the molding compound may be exposed on the top or bottom of this product. This purely cosmetic and does not have any effect on quality, reliability or electrical specs.

*Stop using the glue

Any glue must never use it after soldering LC-package to a circuit board. This product has glass on the back side of a package. When glue invasions between circuit board side and glass side, then glass cracks by thermal expansion of glue. In this case a crystal oscillation stops. Consider glue abolition or glue do not touch to LC-package

Specifications (characteristics)

* Refer to application manual for details.

Recommended Operating Conditions

Item	Symbol	Conditions	Min.	Typ.	Max.	Unit
Power voltage	VDD	—	1.6	3.0	5.5	V
Clock voltage	VCLK	T _a = +25 °C	1.0	3.0	5.5	V
		T _a = -40 to +85 °C	1.1	3.0	5.5	V
Operating temperature	TOPR	—	-40	+25	+85	°C

Frequency characteristics

Item	Symbol	Conditions	Rating	Unit
Frequency tolerance	Δ f / f	T _a = +25 °C VDD = 3.0 V	5 ± 23 *	× 10 ⁻⁶
Oscillation start-up time	t _{STA}	T _a = +25 °C VDD = 1.6 V	1 Max.	s

* Please ask for tighter tolerance. (Equivalent to 1 minute of monthly deviation)

Current consumption characteristics

T_a = -40 °C to +85 °C

Symbol	Conditions	Min.	Typ.	Max.	Unit
I _{BK}	CE = GND /IRQ = OFF FOUT ; output OFF (Hi - z)	VDD = 5 V	0.40	1.00	μA
		VDD = 3 V	0.32	0.95	
I _{32k}	CE = GND /IRQ = OFF FOUT ; 32.768 kHz output ON CL = 30 pF	VDD = 5 V	8.0	14.0	μA
		VDD = 3 V	5.0	8.5	

PROMOTION OF ENVIRONMENTAL MANAGEMENT SYSTEM CONFORMING TO INTERNATIONAL STANDARDS

At Seiko Epson, all environmental initiatives operate under the Plan-Do-Check-Action (PDCA) cycle designed to achieve continuous improvements. The environmental management system (EMS) operates under the ISO 14001 environmental management standard.

All of our major manufacturing and non-manufacturing sites, in Japan and overseas, completed the acquisition of ISO 14001 certification.

ISO 14000 is an international standard for environmental management that was established by the International Standards Organization in 1996 against the background of growing concern regarding global warming, destruction of the ozone layer, and global deforestation.



WORKING FOR HIGH QUALITY

In order provide high quality and reliable products and services than meet customer needs,

Seiko Epson made early efforts towards obtaining ISO9000 series certification and has acquired ISO9001 for all business establishments in Japan and abroad. We have also acquired ISO/TS 16949 certification that is requested strongly by major automotive manufacturers as standard.

ISO/TS16949 is the international standard that added the sector-specific supplemental requirements for automotive industry based on ISO9001.

► Explanation of the mark that are using it for the catalog

	<p>► Pb free.</p>
	<p>► Complies with EU RoHS directive. *About the products without the Pb-free mark. Contains Pb in products exempted by EU RoHS directive. (Contains Pb in sealing glass, high melting temperature type solder or other.)</p>
	<p>► The products have been designed for high reliability applications such as Automotive.</p>

Notice

- This material is subject to change without notice.
- Any part of this material may not be reproduced or duplicated in any form or any means without the written permission of Seiko Epson.
- The information about applied circuitry, software, usage, etc. written in this material is intended for reference only. Seiko Epson does not assume any liability for the occurrence of infringing on any patent or copyright of a third party. This material does not authorize the licensing for any patent or intellectual copyrights.
- When exporting the products or technology described in this material, you should comply with the applicable export control laws and regulations and follow the procedures required by such laws and regulations.
- You are requested not to use the products (and any technical information furnished, if any) for the development and/or manufacture of weapon of mass destruction or for other military purposes. You are also requested that you would not make the products available to any third party who may use the products for such prohibited purposes.
- These products are intended for general use in electronic equipment. When using them in specific applications that require extremely high reliability, such as the applications stated below, you must obtain permission from Seiko Epson in advance.
/ Space equipment (artificial satellites, rockets, etc.) / Transportation vehicles and related (automobiles, aircraft, trains, vessels, etc.) / Medical instruments to sustain life / Submarine transmitters / Power stations and related / Fire work equipment and security equipment / traffic control equipment / and others requiring equivalent reliability.
- All brands or product names mentioned herein are trademarks and/or registered trademarks of their respective.